

POWERED SPEAKER YST-M40/M45D

SERVICE MANUAL

■ CONTENTS

FRONT PANELS	1
REAR PANELS	1
INSTALLING AND VERIFYING THE YST-M45D SPEAKER	
DEVICE DRIVERS	2
EXPLODED VIEW (YST-M40)	4
EXPLODED VIEW (YST-M45D)	5

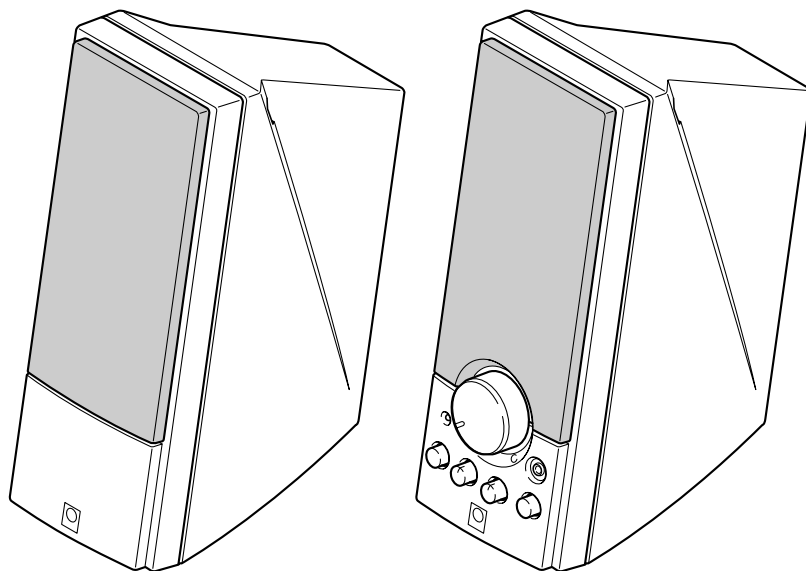

■ SPECIFICATIONS

Type	Advanced Yamaha Active Servo Technology
Output Power	12W + 12W (1kHz, 4Ω)
Input Sensitivity	200mV (1kHz, 4Ω at 12W)
Input Impedance	20kΩ
Frequency Response	70Hz to 20kHz
Speaker Unit	8cm (3.5") full-range cone, magnetic shielding
Output Impedance	330Ω
Output Level	0.7V (at 200mV Rated Input)
Power Supply	DC 15V

Dimensions (W x H x D)

Right channel	95 x 248 x 203 mm (3.74" x 9.76" x 7.99")
Left channel	95 x 248 x 199 mm (3.74" x 9.76" x 7.83")

Weight

Right channel	1.1 kg (2.43 lbs.)
Left channel	0.8 kg (1.76 lbs.)

Finish	YST-M40W/YST-M45DW: Computer white YST-M40B/YST-M45DB: Black
---------------------	---

Accessories	AC Adaptor (DC15V, 1.2A) x 1 3.5mm stereo mini plug cable (1.8 m) x 1 RCA pin plug cable (1.8 m) x 1 8pcs of non skid pads x 1 set USB cable (2 m) x 1 / CD-ROM x 1 (YST-M45D only)
--------------------------	---



このサービスマニュアルは、エコマーク認定の再生紙を使用しています。
This Service Manual uses recycled paper.

* Specifications are subject change without notice due to product improvements.



FRONT PANELS

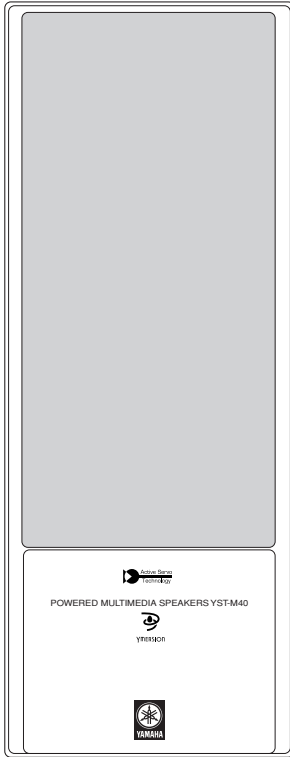

YST-M40 (L ch)

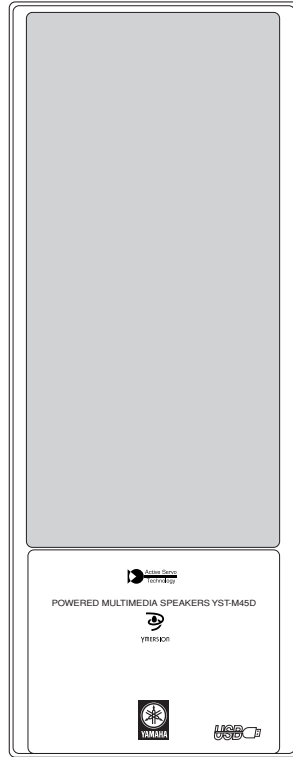

YST-M45D (L ch)

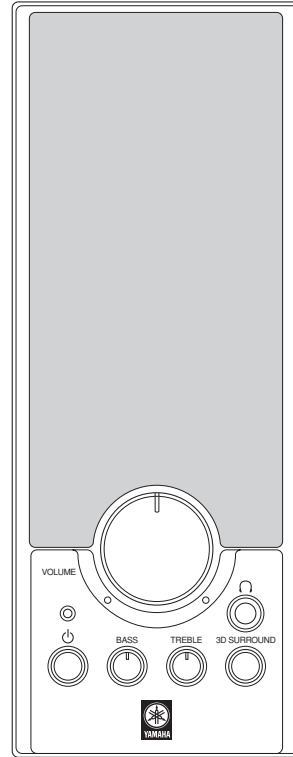

YST-M40/M45D (R ch)

REAR PANELS

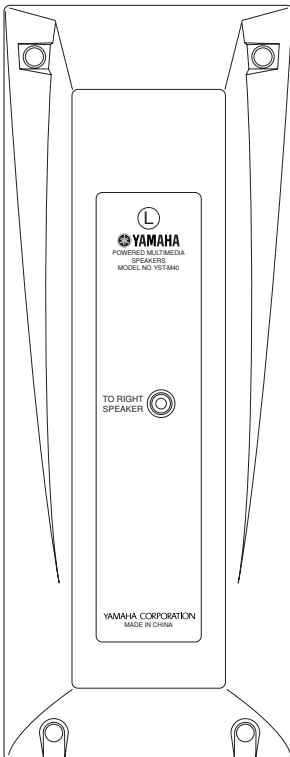

YST-M40 (L ch)

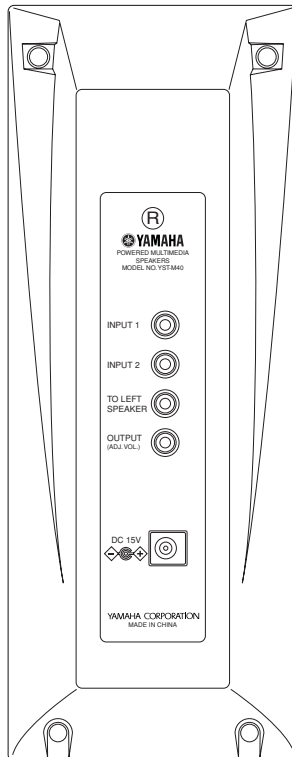

YST-M40 (R ch)

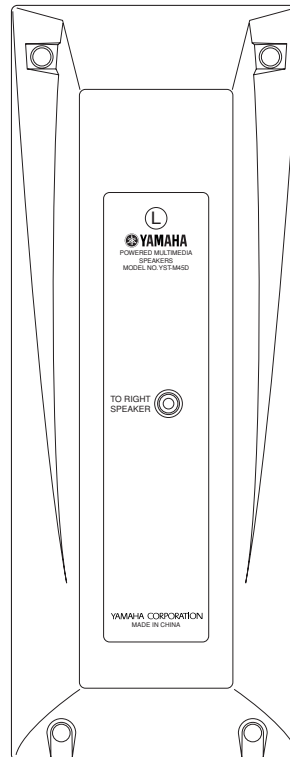

YST-M45D (L ch)

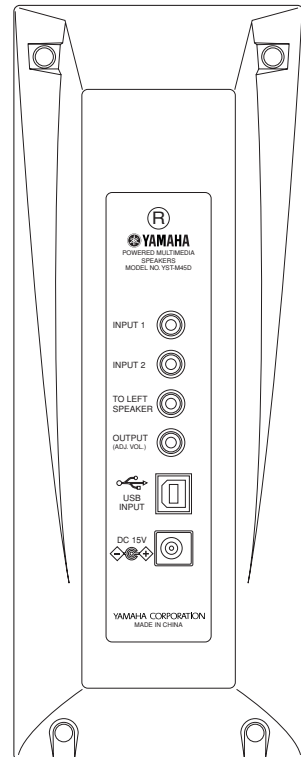

YST-M45D (R ch)

■ INSTALLING AND VERIFYING THE YST-M45D SPEAKER DEVICE DRIVERS

Please follow these steps to install the Yamaha YST-M45D speaker device drivers in your Windows 98 system using the included CD-ROM, and verify that Windows 98 recognizes the installed device drivers and that audio CD, sound generated while using software, and system sounds from the computer will be output via the USB port.

Installing the device drivers

Notes:

- Do not connect the PC using the USB cable before installing the YST-M45D device drivers. If you accidentally connect them, refer to "Reinstalling the Device Driver" on page 3.
- Before starting, check the "System Requirements" section to see if your PC supports YST-M45D.
- Make sure that no other CD-ROM is loaded in the CD-ROM drive and that you quit all application programs.
- Have your Windows 98 CD-ROM ready when you install the Yamaha YST-M45D speaker device drivers. You may need it in some cases.
- The installation procedure may differ from the following instructions depending on the system environment. Follow the instructions that appear in the dialog box. Please contact your computer's manufacturer or dealer if you have any questions.

1. Connect the YST-M45D speakers as shown in the diagram on page 2 of Owner's Manual and connect the AC adaptor to the AC receptacle. At this time, do not connect the YST-M45D to the computer using the USB cable.
2. Turn on your PC and, if it's not running already, start Windows 98.
3. Insert the YAMAHA YST-M45D CD-ROM into the CD-ROM or DVD-ROM drive.
If the Windows 98 Autorun feature is turned on, the installation start up screen appears automatically.
4. Continue with the installation as prompted.
If the Windows 98 Autorun feature is not turned on, you must start the installation manually, as explained below.
5. Double-click the My Computer icon.
The My Computer window opens.
6. Double-click the CD-ROM icon.
The installation start up screen appears.
7. Continue with the installation as prompted.
8. After the installation is completed, connect the YST-M45D to the computer using the USB cable.

Verifying the installation of device drivers

After you have installed the device drivers as explained in the previous section, follow the steps below to verify that Windows 98 recognizes these drivers.

1. Select "Start," then select "Settings-->Control Panel" from the menu.
2. Double-click "System" in the control Panel to display the "System Properties" panel, select the "Device Manager" tab, then select "View devices by type."
3. Click the plus sign (+) for "Human Interface Devices," "Sound, video and game controllers," and "Universal Serial Bus Controller" in the device list, and check to see if "Human Interface Devices," "YAMAHA YST-M45D USB Audio," and "YAMAHA YST-M45D USB Composite Device" are listed respectively.

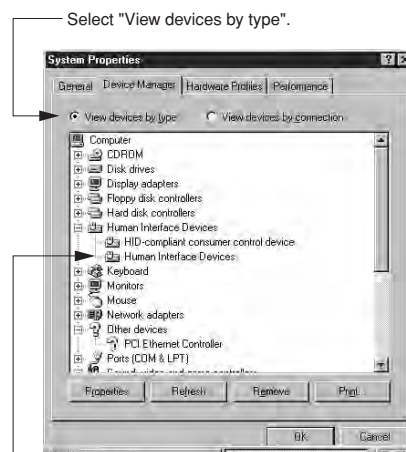

"Human Interface Devices" is listed.

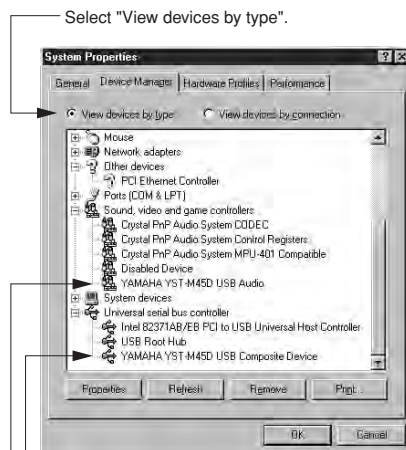

"YAMAHA YST-M45D USB Composite Device" is listed.

"YAMAHA YST-M45D USB Audio" is listed.

- The contents of the list on the display shown above may vary depending on the system environment.

Note: If the letter an exclamation point (!), or a question mark (?) appears to the left of the USB device name, check the following:

- Make sure that you have installed the drivers from the included CD-ROM.
- Check to see if the USB cable is connected securely.
- The AC adaptor plug is connected to the AC receptacle.

If these actions do not resolve the situation, refer to your Windows documentation or ask your computer dealer to enable the USB port.

Re-installing the Device Driver

If you connect the PC and the YST-M45D via the USB ports using the USB cable before you install the included application software, the YST-M45D device driver will not recognize the devices correctly, and will display the following items in the "System Properties" window:

- USB Audio Device in the list of "Sound, video and game controllers"
- USB Composite Device in the list of "Universal serial bus controller"

To recognize the devices correctly, re-install the driver following the steps below:

1. Make sure the YST-M45D is connected to the PC via the USB cable.
2. Click the "+" symbol next to "Universal serial bus controller" to display the list.
3. Make sure that "USB Composite Device" appears in the list and click to select it.

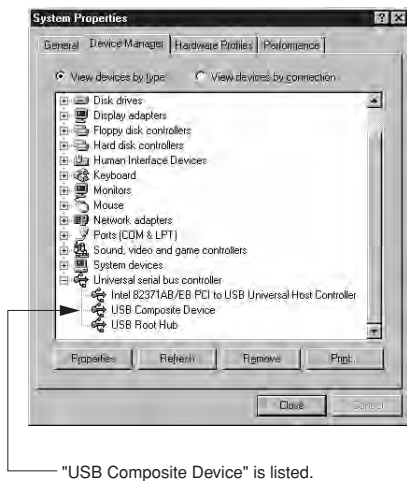

4. Click [Remove].
The dialog shown below appears. Click [OK].
"USB Audio Device" will be deleted.



5. Make sure that "USB Composite Device" has been deleted from the list of "Universal serial bus controller."
6. Disconnect the USB cable.
7. Insert the included CD-ROM into the CD-ROM drive and re-install the device driver.
8. Check the device driver. Refer to "Verifying the installation of device drivers" on page 2.

Ensuring the output of audio data from the USB port

Follow the steps below to ensure that the USB port on your computer is ready to output CD audio.

1. Select "Start," then select "Settings-->Control Panel" from the menu.
2. Double-click "Multimedia" icon in the Control Panel to display the "Multimedia Properties" window, and under "Playback" in the "Audio" tab, make sure that "YAMAHA YST-M45D USB Audio" is selected as the "Preferred device."
(Depending on the computer, if multiple USB audio devices are connected, the number of devices may appear in parentheses.)

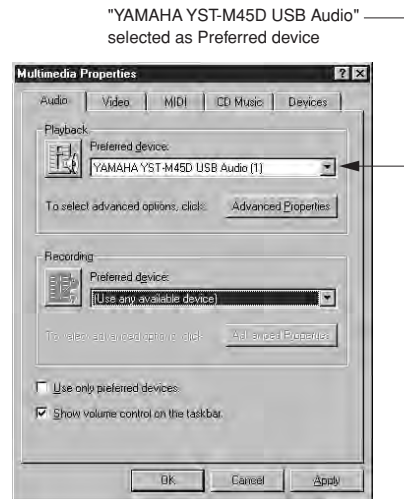

- The contents of the list on the display shown left may vary depending on the system environment.

3. Select the "CD Music" tab, make sure that the text below the "CD Music Volume" is Active, and check "Enable digital CD audio for this CD-ROM device."
If the text below "CD Music Volume" appears in gray, you cannot check the "Enable digital CD audio for this CD-ROM device" box. In this case, your CD-ROM drive may not be supported. Consult your computer manufacturer or dealer.

Enable digital CD audio for this CD-ROM device

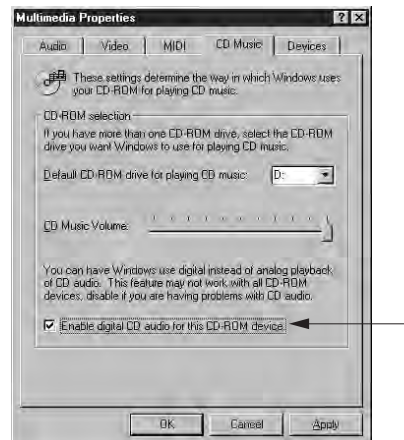

- The contents of the list on the display shown left may vary depending on the system environment.

Now you are ready to enjoy your YST-M45D Speaker System!

■ EXPLODED VIEW (YST-M40)

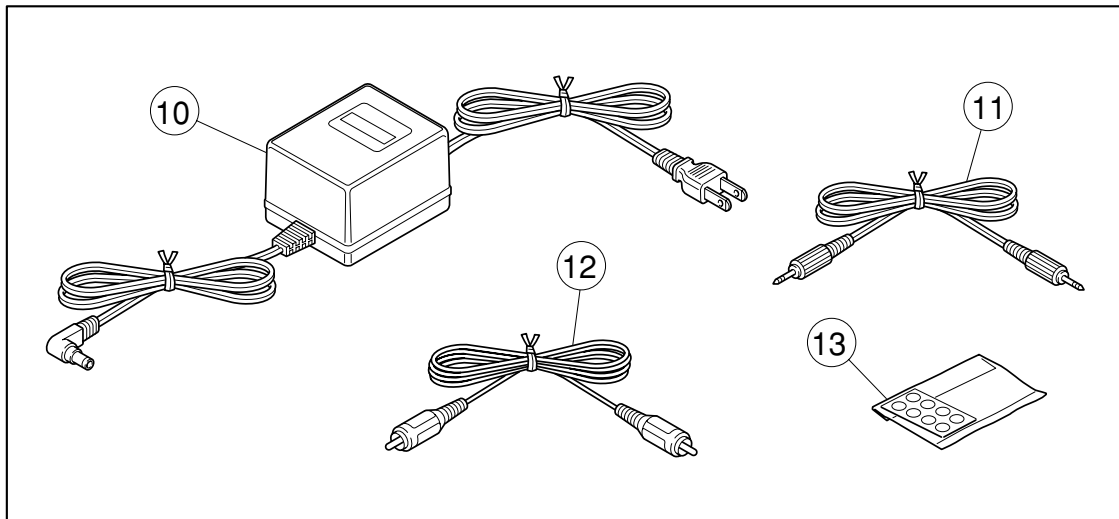
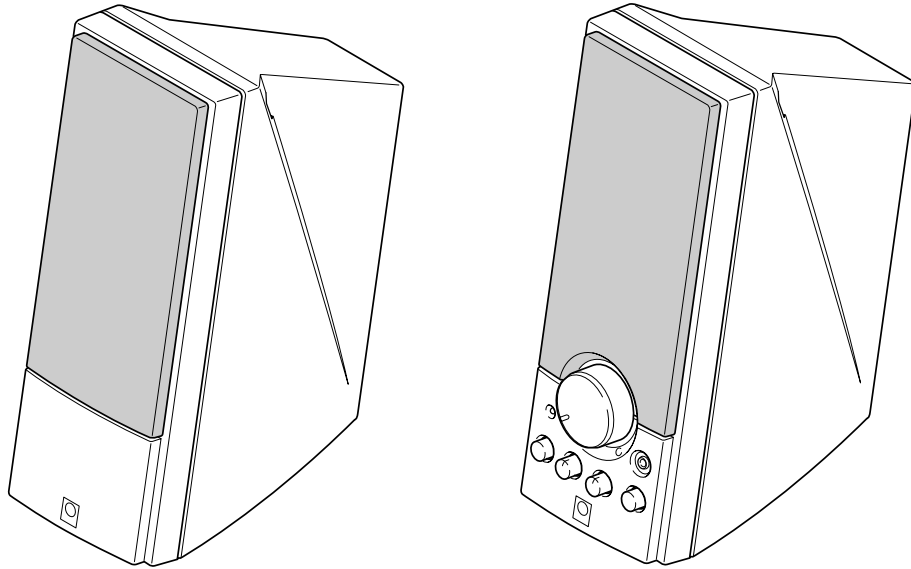

■ PARTS LIST

Ref. No.	PART NO.	Description	Remarks	Markets
10	V4609900	AC ADAPTOR	DC15V 1.2A	(G)
10	V4609700	AC ADAPTOR	DC15V 1.2A	(A)
10	V4609800	AC ADAPTOR	DC15V 1.2A	(B)
10	V4609500	AC ADAPTOR	DC15V 1.2A	(UC)
11	VS494400	CABLE, MINI PLUG	1.8m	
12	VT309500	RCA PIN CABLE	1.8m	
13	VS104300	LEG	8pcs. NONSKID PADS	

* New Parts

■ EXPLODED VIEW (YST-M45D)

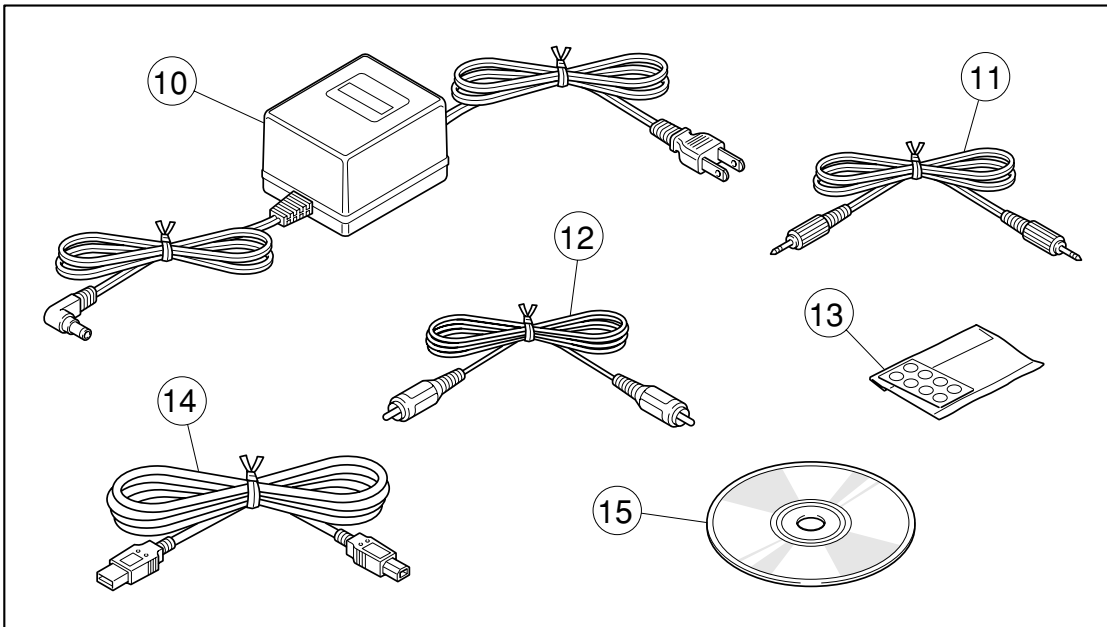
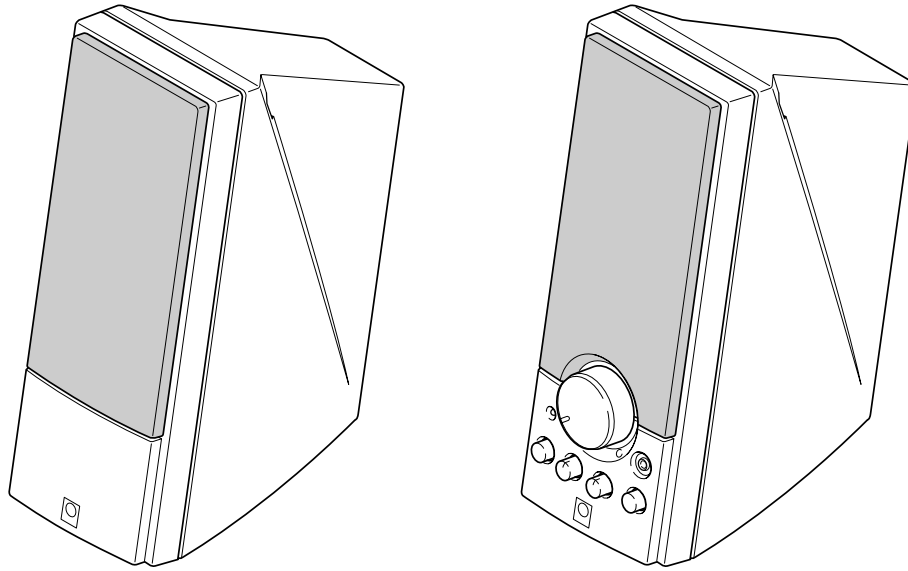

■ PARTS LIST

Ref. No.	PART NO.	Description	Remarks	Markets
10	V4609500	AC ADAPTOR	DC15V 1.2A	(UC)
10	V4609700	AC ADAPTOR	DC15V 1.2A	(A)
10	V4609800	AC ADAPTOR	DC15V 1.2A	(B)
10	V4609900	AC ADAPTOR	DC15V 1.2A	(G)
11	VS494400	CABLE, MINI PLUG	1.8m	
12	VT309500	RCA PIN CABLE	1.8m	
13	VS104300	LEG	8pcs. NONSKID PADS	
14	V4368200	USB CABLE	1P 2.0m	
15	V5325100	CD-ROM	5.0 052588	

*

* New Parts